



A4 ADVERTENCIA LEGAL

Lege-abisua
Legal warning
Texte Legal
Rechtlicher Hinweis
Advertência legal
Nota prawna

A5 SIMBOLOGÍA

Sinbologia
Symbology
Symbologie
Simbologia
Symbole

A6 ÍNDICE DE MARCAS

Marken Aurkibidea
Brand Index
Index Marque
Hauptmarke
Índice de marcas
Spis marek

1-32 LLAVES

GILTZAK
KEYS
CLES
SCHLÜSSEL
CHAVES
KLUCZE

2-3	AUDI
4-5	BMW
5-6	CHRYSLER
6-12	CITROEN
12	DACIA
12-13	FIAT
13-14	FORD
14-16	LEXUS
16	NISSAN
17-18	OPEL
19-25	PEUGEOT
25-28	RENAULT
29-31	TOYOTA
31-32	VOLKSWAGEN

33-36 OTROS

BESTE BATZUK
OTHERS
AUTRES
ANDERE
OUTRAS
INNE

33-34 ESPADINES

EZPATA
BLADES
LAMES
ZUNGE
LAMINA
GROTY

35-36 TL

TL
HORSESHOES
INSERTS
TL
TL
TL

36 ACCESORIOS

OSAGARRIAK
ACCESSORIES
ACCESSOIRES
ZUBEHÖRTEILE
ACESSORIOS
AKCESORIA

ESPAÑOL

Conforme a las disposiciones legales vigentes relativas a la propiedad industrial, las marcas o nombres comerciales indicados en este catálogo son propiedad exclusiva de los fabricantes de cilindros y cerraduras, así como de los fabricantes de automóviles. Dichas marcas o nombres comerciales se indican en calidad simplemente informativa con el fin de reconocer con rapidez la cerradura a la que corresponden nuestras piezas.

Este catálogo está reservado exclusivamente a profesionales de la reproducción de llaves que utilizan piezas JMA. Los datos referentes a los productos de este catálogo tienen carácter indicativo. Manteniendo siempre las características básicas, nos reservamos el derecho de realizar, sin previo aviso, modificaciones técnicas, estéticas o de otro tipo, por razones de evolución de los productos en cuestión.

EUSKERA

Industria-jabegoari dagozkion indarrean dauden lege-xedapenekin bat etorri, katalogo honetan ageri diren marka edo merkataritza-izenak zilindro eta sarrailen fabrikatzaileen jabego eskusibokoak dira, eta baita ibilgailuen fabrikatzaileena. Aipatutako markak edo merkataritza-izenak modu informatiboan soilik aipatzen dira, gure piezak zein sarrailarekin doazen azkar jakin ahal izateko.

Katalogo hau JMA piezak erabiltzen dituzten giltzen bikoizketara dedikatzen diren profesionali zuzenduta dago. Katalogo honetako produktuei dagozkien datuak azalpen izaera dute. Beti, oinarritzko ezaugarriak mantenduz, aurreko abisurik gabe, produktu horiek eboluzionatzen dutelako, aldaketa teknikoak, estetikoak edo beste motatakoan egiteko eskubidea dugu.

FRANÇAIS

Conformément aux dispositions légales en vigueur relatives à la propriété industrielle, les marques ou les dénominations commerciales citées dans ce catalogue sont la propriété exclusive des fabricants de cylindres et de serrures ainsi que des constructeurs de voitures, autres constructeurs, distributeurs et utilisateurs. Ces marques ou dénominations commerciales sont indiquées à titre de simple information afin de connaître rapidement à quelle serrure nos ébauches sont destinées.

Ce catalogue est exclusivement réservé aux professionnels de la reproduction de clés, utilisant des ébauches JMA. Les renseignements sur les produits de ce catalogue sont donnés à titre indicatif. Tout en gardant les caractéristiques de base, nous nous réservons le droit d'apporter, sans préavis, des modifications techniques, esthétiques ou autres, dues à l'évolution des produits en question.

POTUGUESE

Em conformidade com as disposições legais vigentes sobre a propriedade industrial, as marcas ou nomes comerciais indicados neste catálogo são propriedade exclusiva dos fabricantes de cilindros e fechaduras, assim como dos fabricantes de automóveis. Ditas marcas ou nomes comerciais mencionam-se com propósitos meramente informativos, com o fim de reconhecer com rapidez a fechadura a que correspondem as nossas peças.

Este catálogo está reservado exclusivamente a profissionais da reprodução de chaves que utilizam peças JMA. Os dados referentes aos produtos deste catálogo têm caráter meramente indicativo. Mantendo sempre as características básicas, reservamo-nos o direito de realizar, sem prévio aviso, quaisquer modificações técnicas, estéticas ou de outro tipo, resultantes da evolução dos produtos em questão.

ENGLISH

In accordance with current legal dispositions related to industrial property, the brands or commercial names indicated in this catalogue are the exclusive property of the manufacturers of cylinders and locks, as well as the manufacturers of automobiles. These brands or commercial names are used as mere information in order to quickly recognise the lock to which our parts correspond.

This catalogue is exclusively reserved to professional key duplicators that use JMA pieces. The data referring to the products of this catalogue is merely informative. Always maintaining the basic characteristics, we reserve the right to making, without previous notification, technical, aesthetic or other types of modifications, for improvement reasons of the products in question.

DEUTSCH

Gemäß den geltenden gesetzlichen Bestimmungen bezüglich des gewerblichen Eigentums, der Marken oder Handelsnamen, die in diesem Katalog angegeben sind, sind diese ausschließliches Eigentum der Hersteller der Zylinder und Schlösser sowie der Fahrzeughersteller. Diese Marken oder Handelsnamen werden aus rein informativen Gründen angegeben, um die Schlösser, zu denen unsere Teile gehören, schneller zu erkennen.

Dieser Katalog ist ausschließlich für Fachleute auf dem Gebiet der Reproduktion von Schlüsseln gedacht, die Teile von JMA verwenden. Die Daten bezüglich der Produkte dieses Katalogs haben indikativen Charakter. Unter Beibehaltung der grundlegenden Charakteristiken behalten wir uns das Recht vor, ohne Vorankündigung technische, ästhetische oder sonstige Modifikationen aufgrund der Weiterentwicklung der fraglichen Produkte vorzunehmen.

POLSKI

Zgodnie z aktualnymi przepisami prawnymi związanymi z ochroną własności przemysłowej, marki i nazwy handlowe wymienione w tym katalogu są wyłączną własnością producentów wkładek i zamków, oraz producentów samochodów. Zarówno marki jak i nazwy handlowe są wykorzystywane jedynie w celu szybkiego rozpoznania zamka, któremu odpowiadają nasze produkty.

Ten katalog jest zarezerwowany wyłącznie dla profesjonalistów kopiowania kluczy korzystających z produktów JMA. Informacje odnoszące się do produktów w katalogu mają charakter orientacyjny. Przy zachowaniu podstawowych parametrów, zastrzegamy sobie prawo, bez uprzedniego powiadomienia, do zmian technicznych, estetycznych lub innych, w celu poprawy produktów.

SIMBOLOGÍA

SIMBOLOGY

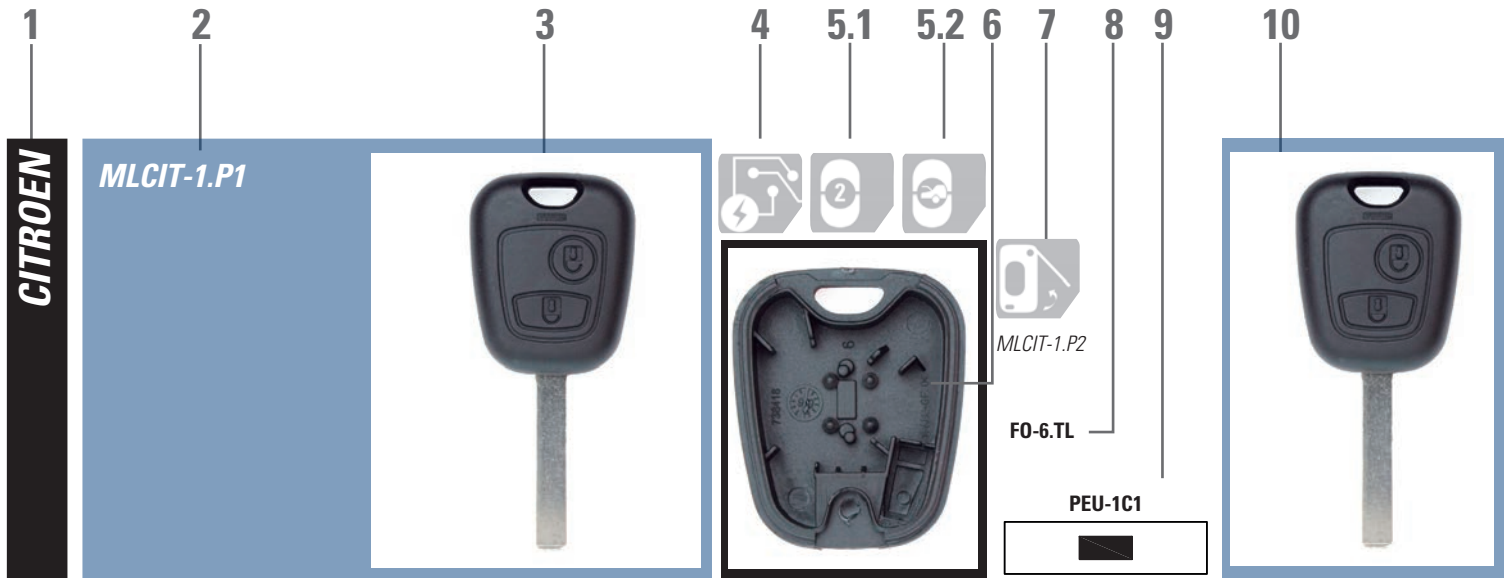

1. MARCA

1. MARKA
1. BRAND
1. MARQUE
1. MARKE
1. MARCA
1. MARKA

2. REF. JMA

2. ERREF. JMA
2. REF. JMA
2. REF. JMA
2. REF. JMA
2. REF. JMA
2. SYMBOL JMA

3. IMAGEN JMA

3. JMA IRUDIA
3. IMAGE JMA
3. IMAGE JMA
3. BILD JMA
3. IMAGEM JMA
3. ZDJĘCIE JMA

4. DETALLES PILA

4. PILAREN XEHETASUNAK
4. DETAILS BATTERY
4. DETAIL PILE
4. DETAILS BATT
4. DETALHES PILA
4. INFORMACJE O BATERII

5. BOTONES (1-NÚMERO/2-TIPO)

5. BOTOIAK (1-ZENBAKIA/2-MOTA)
5. BUTTONS (1-NUMBER/2-TYPE)
5. BOUTON(1-NUMERO/2-TYPE)
5. KNÖPFE (1-ANZAHL/2-TYP)
5. BOTÕES (1-NÚMERO/2-TIPO)
5. PRZYCISKI (1-ILOŚĆ/2-TYP)

6. IMAGEN DETALLADA

6. IRUDI XEHEA
6. DETAILED IMAGE
6. IMAGE DE DETAIL
6. DETAILLIERTES BILD
6. IMAGEM DETALHADA
6. SZCZEGÓŁOWE ZDJĘCIE

7. CONVERTIBILIDAD

7. BIHURGARRITASUNA
7. CONVERTIBILITY
7. CONVERTIBLE
7. KONVERTIERBARKEIT
7. CONVERTIBILIDADE
7. ZAMIENNIK

8. COMPATIBILIDAD TL

8. TL BATERGARRITASUNA
8. COMPATIBILITY TL
8. INSERT COMPATIBLE
8. KOMPATIBILITÄT
8. COMPATIBILIDADE TL
8. KOMPATYBILNOŚĆ TL

9. ESPADIN JMA

9. JMA EZPATA
9. BLADE JMA
9. LAME JMA
9. ZUNGE JMA
9. LAMINA JMA
9. GROT JMA

10. LLAVE ORIGINAL

10. JATORRIZKO GILTZA
10. ORIGINAL KEY
10. CLE ORIGINALE
10. ORIGINALSCHLÜSSEL
10. CHAVE ORIGINAL
10. KLUCZ ORYGINALNY

BOTONES/BUTTONS



PILA/BATTERY

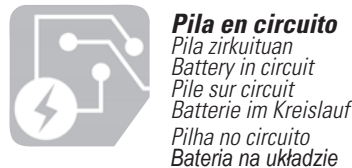

ESCAMOTEABLE/FLIP KEY



ÍNDICE DE MARCAS

MARKEN AURKIBIDEA • BRAND INDEX • INDEX MARQUE • HAUPTMARKE • ÍNDICE DE MARCAS • SPIS MAREK

REF.	PAG.	REF.	PAG.	REF.	PAG.	REF.	PAG.
AUDI		MLHU-HCA.P3	9	NISSAN		RENAULT	
MLAU01	2	MLHU-HCA.P4	10	MLNS01	16	MLCIT-1.P8	25
MLAU02	2	MLHU-HCA.P5	10	OPEL		MLCIT-1.P9	25
MLAU03	2	MLHU-HCA.P6	10	MLNE-38.P8	17	MLNE-38.P7	25
MLAU04	2	MLHU-HCA.P7	10	MLNE-38.P11	17	MLNE-38.P8	26
MLAU05	3	MLHU-HCA.P9	11	MLNE-38.P12	17	MLNE-38.P9	26
MLAU06	3	MLNE-38.P5	11	MLOP01	17	MLNE-38.P10	26
MLAU07	3	MLNE-38.P6	11	MLOP02	18	MLNE-38.P11	26
MLHU-HAA.P2	3	MLSIX-3.P4	11	MLOP03	18	MLNE-38.P12	27
BMW		MLSIX-3.P5	12	MLOP-11.P3	18	MLNE-38.P13	27
MLBM01	4	MLSIX-3.P6	12	MLOP-11.P4	18	MLVA-34.P5	27
MLBM-5.P1	4	DACIA		PEUGEOT		MLVA-34.P6	27
MLBM-5.P2	4	MLVA-34.P9	12	MLCIT-1.P1	19	MLVA-34.P7	28
MLBM-6.P2	4	FIAT		MLCIT-1.P2	19	MLVA-34.P8	28
MLBM-6.P3	5	MLFI-16.P2	12	MLCIT-1.P3	19	MLVA-34.P9	28
CHRYSLER		MLFI-16.P3	13	MLCIT-1.P4	19	MLVA-34.P10	28
MLCHR01	5	MLHU-HCA.P1	13	MLCIT-1.P5	20	MLCIT-1.P1	29
MLCHR02	5	MLHU-HCA.P2	13	MLCIT-1.P6	20	MLCIT-1.P2	29
MLCHR03	5	FORD		MLCIT-1.P10	20	MLTOYO01	29
MLCHR04	6	MLF001	13	MLCIT-1.P7	20	MLTOYO-15.P3	29
MLCHR-15.P2	6	MLF002	14	MLHU-HCA.P1	21	MLTOYO-15.P4	30
MLCHR-15.P3	6	MLF003	14	MLHU-HCA.P2	21	MLTOYO-15.P5	30
CITROEN		LEXUS		MLHU-HCA.P3	21	MLTOYO-15.P6	30
MLCIT01	6	MLHU-HCA.P1	14	MLHU-HCA.P9	21	MLTOYO-19.P1	30
MLCIT02	7	MLHU-HCA.P2	14	MLHU-HCA.P4	22	MLTOYO-19.P2	31
MLCIT-1.P1	7	MLTOYO01	15	MLHU-HCA.P5	22	MLTOYO-30.P2	31
MLCIT-1.P2	7	MLTOYO-15.P3	15	MLHU-HCA.P6	22	MLTOYO-36.P1	31
MLCIT-1.P3	7	MLTOYO-15.P5	15	MLHU-HCA.P7	22	VOLKSWAGEN	
MLCIT-1.P4	8	MLTOYO-15.P6	15	MLHU-HCA.P8	23	MLV001	31
MLCIT-1.P5	8	MLTOYO-19.P2	16	MLNE-38.P5	23	MLV002	32
MLCIT-1.P6	8	MLTOYO-30.P2	16	MLNE-38.P6	23		
MLCIT-1.P10	8	MLTOYO-36.P1	16	MLNE-51.P3	23		
MLCIT-1.P7	9			MLNE-51.P4	24		
MLHU-HCA.P1	9			MLNE-51.P5	24		
MLHU-HCA.P2	9			MLNE-51.P6	24		
				MLSIX-3.P4	24		
				MLSIX-3.P5	25		

















CARCASAS PARA LLAVES DE VEHÍCULOS *CAR KEY SHELLS*



2014







CKS.01

THE KEY TO EXCELLENCE
GLOBALLY UNLOCKING MILLIONS OF DOORS DAILY

®	REF. JMA	DETAILS	ORIGINAL
AUDI	<p>MLAU01</p> 	<p>2032</p>   <p>HU-HAA.TLV</p>	
	<p>MLAU02</p> 	<p>1616</p>   <p>HU-HAA.TLV</p>	
	<p>MLAU03</p> 	<p>2032</p>   <p>HU-HAA.TLV</p>	
	<p>MLAU04</p> 	<p>1616</p>   <p>HU-HAA.TLV</p>	









KEY SHELLS

®	REF. JMA	DETAILS	ORIGINAL
AUDI	<p>MLAU05</p> 	<p>2</p> 	
	<p>MLAU06</p> 	<p>3</p> 	
	<p>MLAU07</p> 	<p>3</p> 	
	<p>MLHU-HAA.P2</p> 	<p>3</p>  <p>HU-HAAC4</p> 	



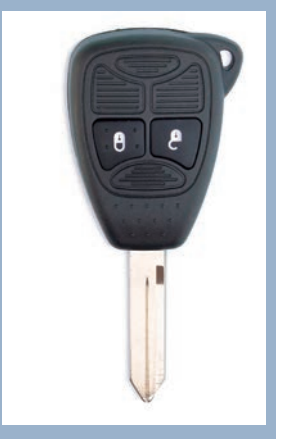

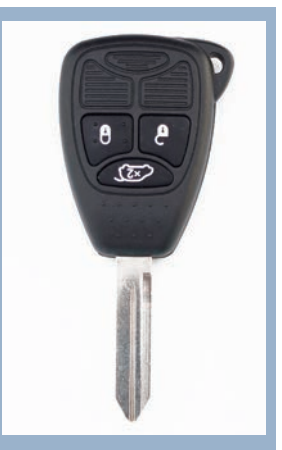

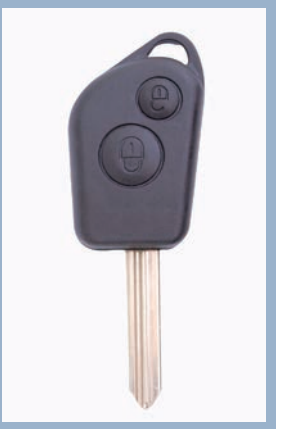



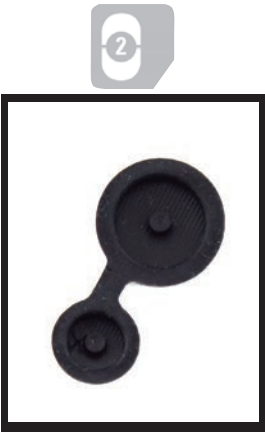



®	REF. JMA	DETAILS	ORIGINAL
BMW	MLBM01	 	
	MLBM-5.P1	 	
	MLBM-5.P2	 	
	MLBM-6.P2	 	















KEY SHELLS

®	REF. JMA	DETAILS	ORIGINAL
BMW	<p>MLBM-6.P3</p> 	 	
CHRYSLER	<p>MLCHR01</p> 	 	
	<p>MLCHR02</p> 	 	
	<p>MLCHR03</p> 	 	

®	REF. JMA	DETAILS	ORIGINAL
CHRYSLER	MLCHR04	 	
	MLCHR-15.P2	 	
	MLCHR-15.P3	 	
CITROEN	MLCIT01	 	









KEY SHELLS

®	REF. JMA	DETAILS	ORIGINAL
CITROEN	<p>MLCIT02</p> 		
	<p>MLCIT-1.P1</p> 	 <p>MLCIT-1.P2</p> 	
	<p>MLCIT-1.P2</p> 	 <p>PEU-1C1</p> 	
	<p>MLCIT-1.P3</p> 	 <p>PEU-1C1</p> 	

®	REF. JMA	DETAILS	ORIGINAL
CITROEN	MLCIT-1.P4	  PEU-1C1 	
	MLCIT-1.P5	  PEU-1C1 	
	MLCIT-1.P6	  PEU-1C1 	
	MLCIT-1.P10	  PEU-1C1 	

KEY SHELLS

®	REF. JMA	DETAILS	ORIGINAL
CITROËN	<p>MLCIT-1.P7</p> 	  <p>PEU-1C1</p> 	
	<p>MLHU-HCA.P1</p> 	  <p>MLHU-HCA.P2</p> 	
	<p>MLHU-HCA.P2</p> 	 	
	<p>MLHU-HCA.P3</p> 	 	

®	REF. JMA	DETAILS	ORIGINAL
CITROEN	MLHU-HCA.P9	 	
	MLHU-HCA.P4	 	
	MLHU-HCA.P5	 	
	MLHU-HCA.P6	 	

KEY SHELLS

®

CITROEN

REF. JMA

DETAILS

ORIGINAL

MLHU-HCA.P7



MLNE-38.P5



MLNE-38.P6

NE-60C3



MLNE-38.P6



MLSIX-3.P4















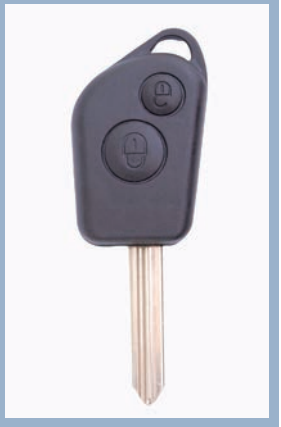

MLSIX-3.P5

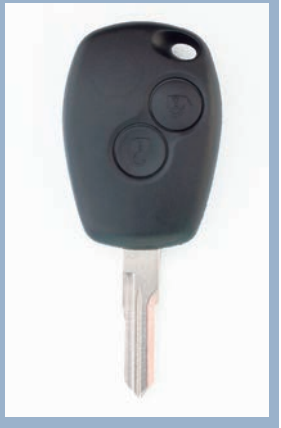

ATENCIÓN: Concerniente a las marcas y denominaciones comerciales ver nota en índice.
ATTENTION: Concerning the marks and commercial denominations see note in index.
ATTENTION: Concernant les marques et dénominations commerciales voir la note dans l'index.

ACHTUNG: Beziehen auf die marke und handelsname sehen sie die notiz im index.
ATENÇÃO: Relativamente às marcas e denominações comerciais, ver nota no índice
UWAGA: W zależności od marki i nazwy handlowej należy zapoznać się z notą w indeksie

®	REF. JMA	DETAILS	ORIGINAL
CITROEN	<p>MLSIX-3.P5</p> 	 	
	<p>MLSIX-3.P6</p> 	 	
DACIA	<p>MLVA-34.P9</p> 	 	
FIAT	<p>MLFI-16.P2</p> 	 	

VA-61C3



KEY SHELLS

®	REF. JMA	DETAILS	ORIGINAL
FIAT	<p>MLFI-16.P3</p> 	 	
	<p>MLHU-HCA.P1</p> 	   <p>MLHU-HCA.P2</p>	
	<p>MLHU-HCA.P2</p> 	 	
FORD	<p>MLF001</p> 	  <p>FO-6.TL</p>	

®	REF. JMA	DETAILS	ORIGINAL
FORD	<p>MLF002</p> 	  <p>FO-6.TL2 FO-24.TL2</p>	
	<p>MLF003</p> 	 	
LEXUS	<p>MLHU-HCA.P1</p> 	  <p>MLHU-HCA.P2</p>	
	<p>MLHU-HCA.P2</p> 	 	

KEY SHELLS

®	REF. JMA	DETAILS	ORIGINAL
LEXUS	MLTOY001 	 	
	MLTOYO-15.P3 	 	
	MLTOYO-15.P5 	 	
	MLTOYO-15.P6 	 	

® REF. JMA DETAILS ORIGINAL

LEXUS

MLTOYO-19.P2



MLTOYO-30.P2



MLTOYO-36.P1



NISSAN

MLNS01











KEY SHELLS

®	REF. JMA	DETAILS	ORIGINAL
OPEL	<p>MLNE-38.P8</p> 	  <p>NE-60C3</p> 	
	<p>MLNE-38.P11</p> 	  <p>NE-60C3</p> 	
	<p>MLNE-38.P12</p> 	  <p>NE-60C3</p> 	
	<p>MLOP01</p> 	  <p>OP-11.TL OP-D.TL OP-S.TL OP-WH.TL</p>	

®	REF. JMA	DETAILS	ORIGINAL
OPEL	<p>MLOP02</p> 	  <p>OP-11.TL OP-D.TL OP-S.TL OP-WH.TL</p>	
	<p>MLOP03</p> 	  <p>OP-11.TL2 OP-D.TL OP-S.TL</p>	
	<p>MLOP-11.P3</p> 	 	
	<p>MLOP-11.P4</p> 	 	









KEY SHELLS

®	REF. JMA	DETAILS	ORIGINAL
PEUGEOT	<p>MLCIT-1.P1</p> 	  <p>MLCIT-1.P2</p> 	
	<p>MLCIT-1.P2</p> 	  <p>PEU-1C1</p> 	
	<p>MLCIT-1.P3</p> 	  <p>PEU-1C1</p> 	
	<p>MLCIT-1.P4</p> 	  <p>PEU-1C1</p> 	











®	REF. JMA	DETAILS	ORIGINAL
PEUGEOT	MLCIT-1.P5	  <p data-bbox="1109 651 1189 678">PEU-1C1</p> 	
	MLCIT-1.P6	  <p data-bbox="1109 1111 1189 1137">PEU-1C1</p> 	
	MLCIT-1.P10	  <p data-bbox="1109 1570 1189 1597">PEU-1C1</p> 	
	MLCIT-1.P7	  <p data-bbox="1109 2029 1189 2056">PEU-1C1</p> 	

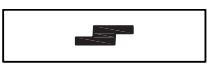













KEY SHELLS

®	REF. JMA	DETAILS	ORIGINAL
PEUGEOT	<p>MLHU-HCA.P1</p> 	  <p>MLHU-HCA.P2</p> 	
	<p>MLHU-HCA.P2</p> 	 	
	<p>MLHU-HCA.P3</p> 	 	
	<p>MLHU-HCA.P9</p> 	 	

















®	REF. JMA	DETAILS	ORIGINAL
PEUGEOT	MLHU-HCA.P4	 	
	MLHU-HCA.P5	 	
	MLHU-HCA.P6	 	
	MLHU-HCA.P7	 	















KEY SHELLS

®	REF. JMA	DETAILS	ORIGINAL
PEUGEOT	<p>MLHU-HCA.P8</p> 	 	
	<p>MLNE-38.P5</p> 	   <p>MLNE-38.P6</p>  <p>NE-60C3</p>	
	<p>MLNE-38.P6</p> 	 	
	<p>MLNE-51.P3</p> 	   <p>MLNE-51.P4</p>	



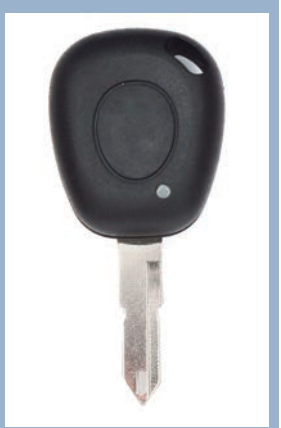













®	REF. JMA	DETAILS	ORIGINAL
PEUGEOT	<p>MLNE-51.P4</p> 	  <p>PEU-2C1</p> 	
	<p>MLNE-51.P5</p> 	  <p>PEU-2C1</p> 	
	<p>MLNE-51.P6</p> 	  <p>PEU-2C1</p> 	
	<p>MLSIX-3.P4</p> 	  <p>MLSIX-3.P5</p> 	





















KEY SHELLS

®	REF. JMA	DETAILS	ORIGINAL
PEUGEOT	<p>MLSIX-3.P5</p> 	 	
	<p>MLCIT-1.P8</p> 	 	
	<p>MLCIT-1.P9</p> 	 	
	<p>MLNE-38.P7</p> 	  <div data-bbox="1046 2024 1251 2107" style="border: 1px solid black; padding: 2px; margin-top: 10px;"> <p>NE-60C3</p>  </div>	

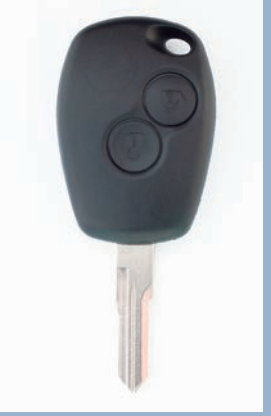









®	REF. JMA	DETAILS	ORIGINAL
RENAULT	MLNE-38.P8	  NE-60C3 	
	MLNE-38.P9	 2016  NE-60C3 	
	MLNE-38.P13	 1620  NE-60C3 	
	MLNE-38.P10	  NE-60C3 	

KEY SHELLS

®	REF. JMA	DETAILS	ORIGINAL
RENAULT	<p>MLNE-38.P11</p> 	<p>⚡ 2</p>  <p>NE-60C3</p> 	
	<p>MLNE-38.P12</p> 	<p>⚡ 3</p>  <p>NE-60C3</p> 	
	<p>MLVA-34.P5</p> 	<p>⚡ 1</p>  <p>VA-61C3</p> 	
	<p>MLVA-34.P6</p> 	<p>⚡ 2</p>  <p>VA-61C3</p> 	

®	REF. JMA	DETAILS	ORIGINAL
RENAULT	MLVA-34.P7	   VA-61C3 	
	MLVA-34.P8	   VA-61C3 	
	MLVA-34.P9	   VA-61C3 	
	MLVA-34.P10	    VA-61C3 	

KEY SHELLS

®	REF. JMA	DETAILS	ORIGINAL
TOYOTA	MLCIT-1.P1	   <p>MLCIT-1.P2</p>	
	MLCIT-1.P2	   <p>PEU-1C1</p>	
	MLTOY001	 	
	MLTOYO-15.P3	 	

®	REF. JMA	DETAILS	ORIGINAL
TOYOTA	MLTOYO-15.P4	 	
	MLTOYO-15.P5	 	
	MLTOYO-15.P6	 	
	MLTOYO-19.P1	 	

KEY SHELLS

®

REF. JMA

DETAILS

ORIGINAL

TOYOTA

MLTOYO-19.P2



MLTOYO-30.P2



MLTOYO-36.P1



VOLKSWAGEN

MLV001



HU-HAA.TLN



®	REF. JMA	DETAILS	ORIGINAL
VOLKSWAGEN	MLV002	  <p>HU-HAA.TLN</p>	

OTROS

BESTE BATZUK
OTHERS
AUTRES
ANDERE
OUTRAS
INNE



2014

CKS.01

THE KEY TO EXCELLENCE
GLOBALLY UNLOCKING MILLIONS OF DOORS DAILY

HUF



ALP.

FO-24C2

NEIMAN

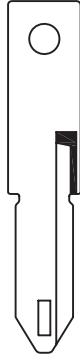

NE-60C1



NE-60C3

VACHETE



VA-61C3

VALEO

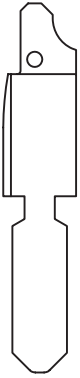

ALP.

PEU-2C1



ALP.
HU-HAAC4

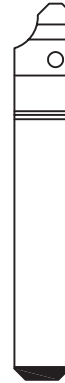

ALP.

PEU-1C1

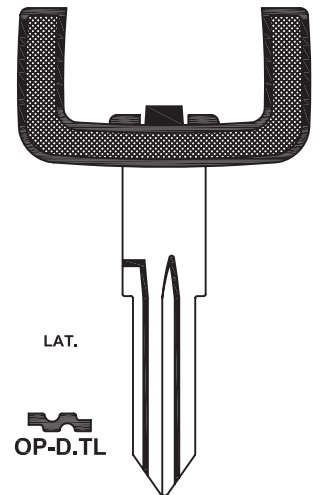
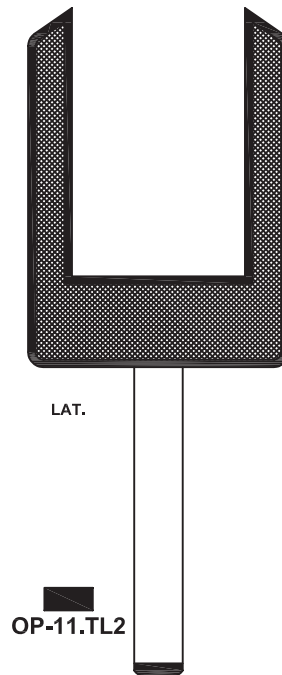
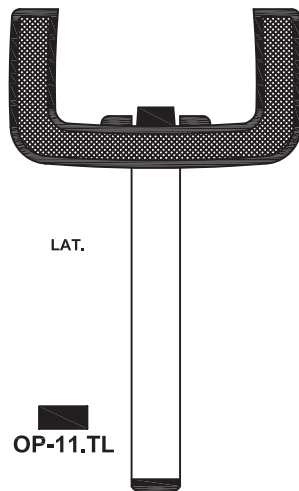
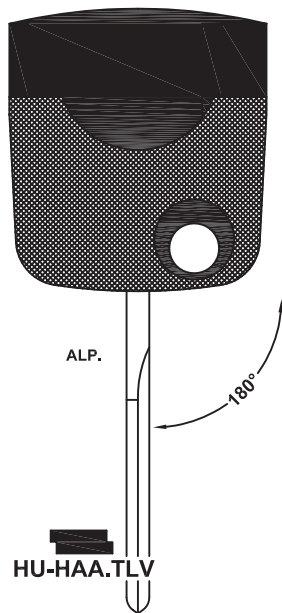
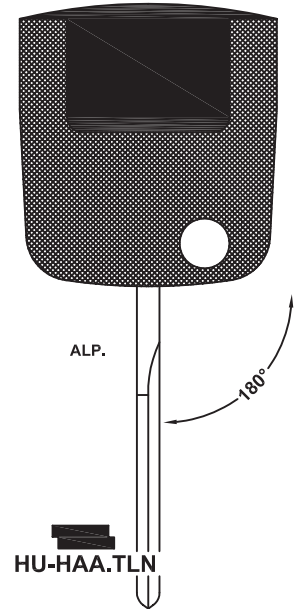
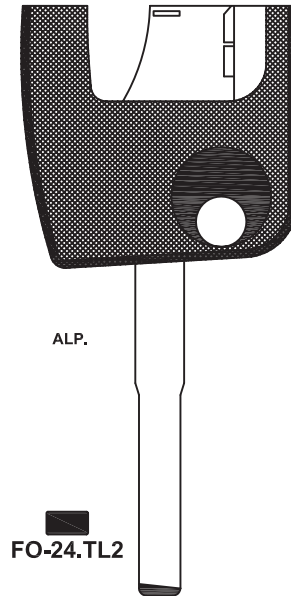
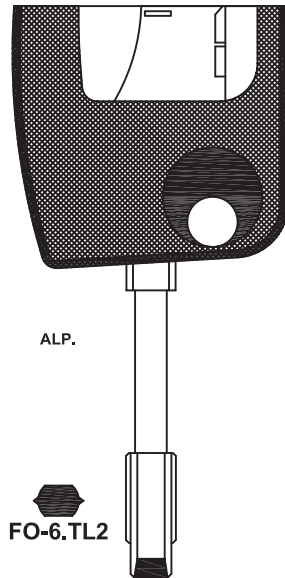
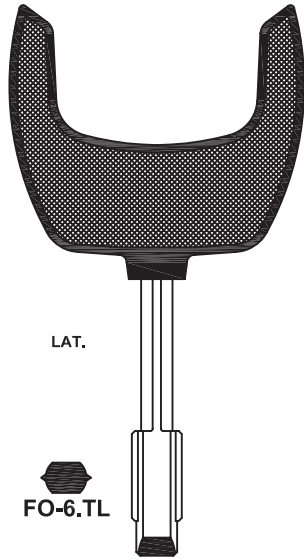

HUF

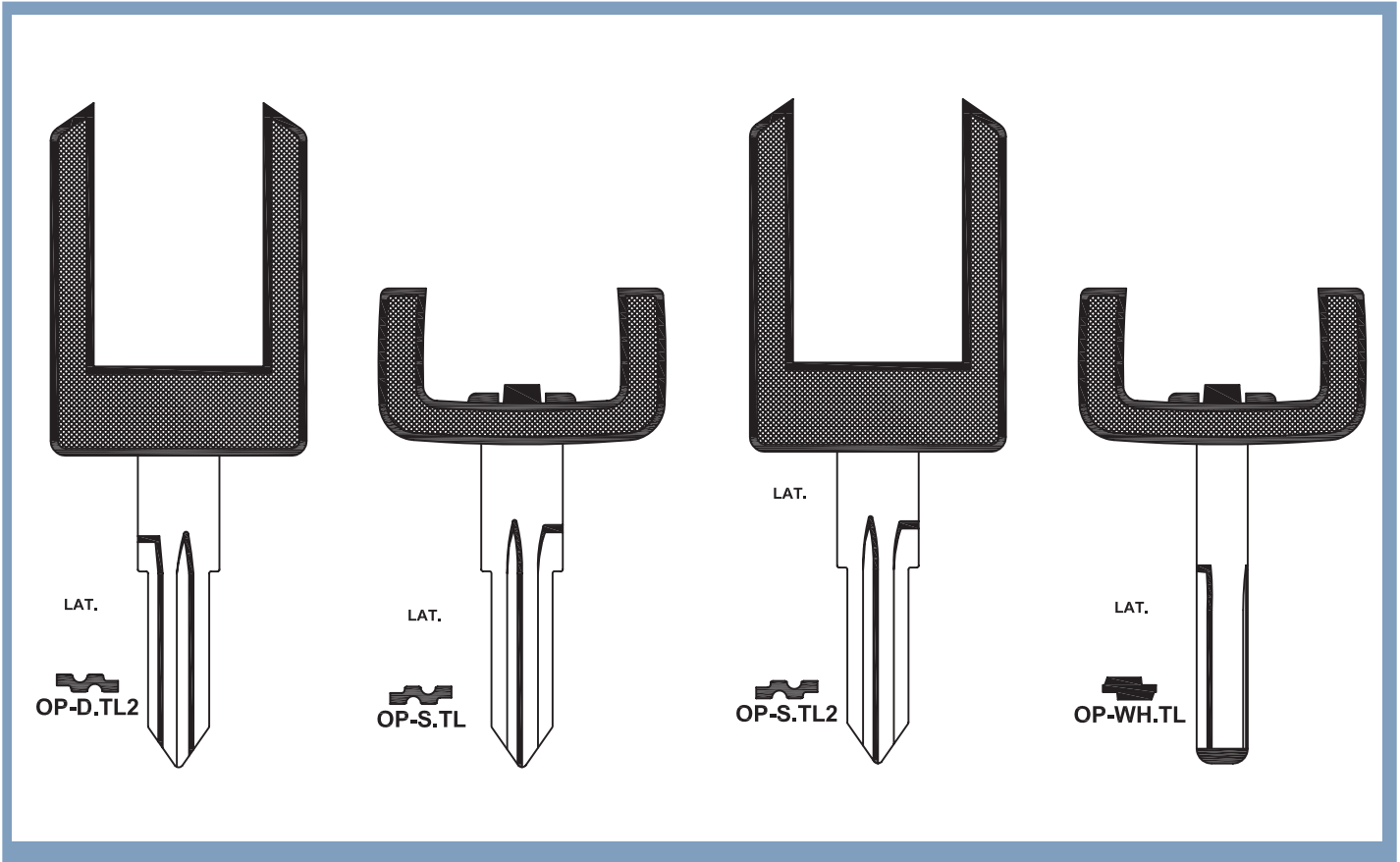

ACCESORIOS ACCESSORIES

SWITCH BLADE



Descripción - Description:

Soporte para cambio de expadines de las llaves escamoteables.

Support jig to enable easy and safe changing of blade of flipkey keys.

128 x 100 x 28 mm (ancho x largo x altura)

128 x 100 x 28 mm (width x length x height)

JMA HEADQUARTERS
ALEJANDRO ALTUNA, S.A.
Tel +34 943 79 30 00
Fax +34 943 79 72 43
Bidekuruzeta, 6
P.O.Box - Apdo. 70
20500 Arrasate - Mondragón
Gipuzkoa - SPAIN

www.jma.es
ventas@jma.es

JMA ARGENTINA
JMA ARGENTINA S.A.
Tel +54 336 4 462 422
Fax +54 336 4 462 422
Av. Central Acero Argentino Oeste 678
Parque industrial COMIRSA
2900 San Nicolas (Prov. Buenos Aires)

www.jma-argentina.com.ar
info@jma-argentina.com.ar

JMA FRANCE
Tel +33 01 39 22 42 10
Fax +33 01 39 22 42 11
Technoparc
13, rue Edouard Jeanneret
F-78306 Poissy Cedex

www.jmafrance.fr
service.commercial@jmafrance.fr

JMA INDIA
JMA KEYS INDIA PVT. LTD
Tel +91 124 428 5450
Fax +91 124 428 5451
H-239 & H-240, Sushant Shopping Arcade
Sushant Lok-1, Block B
122002 Gurgaon
Haryana

www.jmakeys.in
info@jmakeys.in

JMA MAROC
JMA MAROC S.A.R.L.
Tel +0520 150 535
Fax +0520 150 536
83,85 Bd Oued ZIZ, El Oulfa

Casablanca
Marruecos

www.jma.ma
jma@jma.ma

JMA MEXICO
LLAVES ALTUNA DE MEXICO S.A de C.V
Tel +52 33 3777 1600
Fax +52 33 3777 1609
Av. Aviación No. 5520
Col. San Juan de Ocotán
C.P. 45019 Zapopan, Jalisco

www.jma.com.mx
ventas@jma.com.mx

JMA PERÚ
JMA Perú S.A.C.
Tel +51 639 9300
Av. Los Paracas 130, Urbanización Salamanca,
Distrito Ate, Lima

www.jma-peru.com
info@jma-peru.com

JMA POLSKA
JMA POLSKA Sp. z o.o.
Tel +48 42 635 12 80
Fax +48 42 635 12 85
91-342 Łódź, ul. Zbąszyńska 3

www.jmapolska.pl
biuro@jmapolska.pl

JMA PORTUGAL
ALTUNA PORTUGAL
COMERCIO DE CHAVES UNIPessoal, LDA.
Tel +351 219 947 470
Fax +351 219 947 471
Urbanização dos Azeiros, Lote 67 C/v
2695-733 São João da Talha

www.jmaportugal.com
comercial@jmaportugal.com

JMA UK
SKS LTD
Tel +44 144 229 1400
Fax +44 144 286 3663
Unit 2, Canal Side
Northbridge Road
Berkhamsted
Herts HP4 1EG

www.jmakeys.co.uk
sales@skskkeys.co.uk

JMA URUGUAY
JMA URUGUAY S.A.
Tel +598 2908 1175
Fax +598 2900 6681
Mercedes 1420
11100 Montevideo
Uruguay

www.jma.com.uy
info@jma.com.uy

JMA USA
ALTUNA GROUP USA INC.
Tel +1 817 385 0515
Fax +1 817 385 4850
1513 Greenview Drive
75050 Grand Prairie, Texas

www.jmausa.com
info@jmausa.com



Member Of Altuna Group

www.jma.es